

PRODUCT SPECIFICATIONS
KHLDV400 Covington Direct Vent



GLASS VIEWING AREA

32"W x 30"H (754 Square Inches)

TECHNICAL INFORMATION

Max. Btu Input: 40,000 BTU/HR
 Ignition System: Standing Pilot or Signature Command™ System
 Gas Type: Natural or LP
 Flue Type: Simpson Dura-Vent, Selkirk Metalbestos, MetalFab
 Termination: Top vent
 Clearance to Flue for Interior: 3" Top 1" Bottom and Sides
 Clearance to Flue for Outside Wall: 1"
 Clearance to Fireplace: 1"
 Minimum Vent Height Before Elbow: 24"
 CSA Design Certified

FIELD INSTALLED ACCESSORIES

Standing Pilot Variable Thermostat Controlled Dual Forced Air Blower (160 cfm): BLOTKHLTD
 Signature Command Dual Forced with Blower: BLOTKHLSC
 Firebrick (required): Cottage Clay, Cottage Red or Vintage Brown
 Andirons
 Mesh Glass Cover
 Ambient Technologies™ Remote Controls and Thermostats
 Doors (Decorative)
 Field Conversion Kits

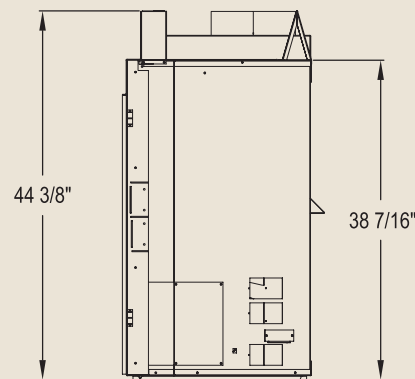
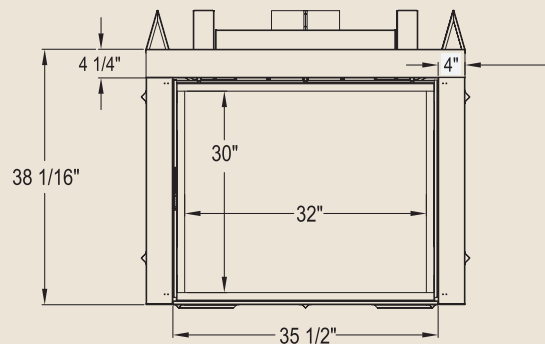
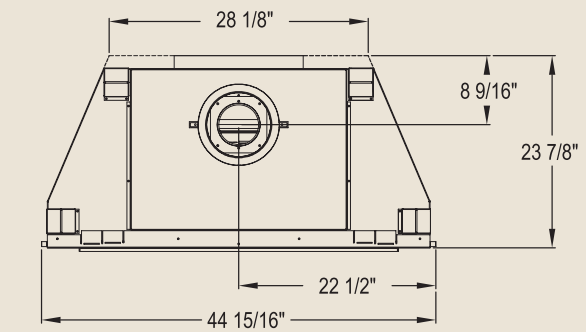

FRAMING DIMENSIONS

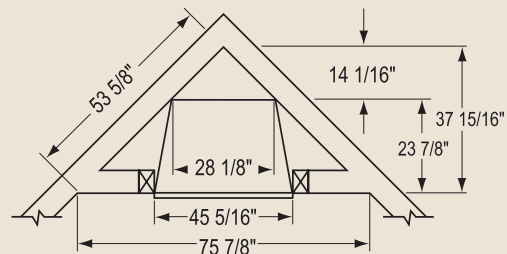

A Brand of Monessen Hearth Systems Co.
 149 Cleveland Drive, Paris, Kentucky 40361

www.monessenhearth.com



To avoid personal injury or property damage, the product described by this brochure must be installed, operated and maintained in strict compliance with the instructions packaged with the product and all applicable building or fire codes. Contact local building or fire officials about restrictions and installation inspection requirements. All photographs and drawings on this brochure are for illustrative purposes only and are not intended for,