



AMERICAN HEARTH



*American Hearth - The Choice for Efficiency*

# Direct-Vent Fireplace Inserts

## *American Hearth – Made in America*

We design every American Hearth fireplace using the best available technology and build each one to the highest-quality standards in our manufacturing facility in Belleville, Illinois.

We make most of our components – from cutting steel to forming to welding to painting – and then hand assemble each fireplace to ensure the best fit and finish. For purchased parts, we give preference to North American suppliers – including our hand-painted log sets, our tempered and ceramic glass, the paint and powder coating, and even the packaging we use to protect our products until they reach your home.

The result is a fireplace that's built to last by experienced craftsmen and craftswomen – a fireplace that's as deeply rooted in history as fire itself – American Hearth.



## *Franklin Traditional & Loft Contemporary*

A Direct-Vent Fireplace Insert turns your existing wood-burning fireplace into an efficient gas-fired heat source.

A wood-burning fireplace sends more than half of its heat up the flue, creating negative pressure in your home, which draws in outside air through gaps in doors and windows that actually makes your home colder. A wood-fire can also create ash and fumes that dirty your home and aggravate your allergies.

Direct-Vent Fireplace Inserts are classified as zone heating appliances. Zone heating is inherently more efficient than your existing wood-burning fireplace or your central furnace. Unlike a central furnace, which wastes 20 to 30 percent of the heat energy through ductwork losses and sends much of the remaining heat to unoccupied rooms, zone heating creates and transmits the heat directly into the room. This lets you turn down your whole-house thermostat and use your fireplace insert to efficiently warm the room you use most.

Our Direct-Vent insert uses readily available 3-inch flexible co-linear vent pipes. One draws air from outside your home, and the other sends flue products directly outdoors. The flexible metal venting allows the insert to install easily in a site-built or manufactured fireplace.

Direct-Vent systems eliminate pressure imbalances in the home that can cause drafts that reduce the effectiveness of heating. At up to 77% AFUE, a traditional or contemporary Direct-Vent Insert makes a great heat source for any room in your home.

# Features

## *Standard Features*

We offer our traditional Franklin Direct-Vent Inserts in three sizes – small, medium, and large – to fit most wood-burning fireplaces. Choose Millivolt ignition with standing pilot to provide heat, even in the absence of electric power, or our Green Earth Preferred Intermittent Pilot, which eliminates the standing pilot to save even more energy. IP systems can operate with a standing pilot during power outages.



Our Franklin Direct-Vent inserts feature Banded Brick Liners and hand-painted ceramic fiber logs, nestled atop the variable flame height burner, to create an exceptionally attractive traditional fireplace. With inputs of 25,000 Btu, 33,000 Btu, and 35,000 Btu, the Direct-Vent insert's unique stainless steel Slope Glaze Flair Burner produces natural flickering flames that dance and delight – warming your heart as it warms your soles.

Awaken your inner artist with a Loft Series Contemporary Direct-Vent Insert – in small (20,000 Btu) or medium (27,000 Btu). Choose Millivolt ignition or Green Earth Preferred Intermittent Pilot. The black porcelain lining inside the Loft insert reflects the mesmerizing flame from the contemporary linear burner to create depth and visual interest from any angle.

## *Surrounds available in Steel and Cast Iron*



# Options & Accessories



*Loft 33,000 Btu Direct-Vent Fireplace Insert shown with Polished Black Decorative Glass and Matte Black metal surround.*

## *Options & Accessories*

Your new direct-vent insert will require a surround, decorative front, or decorative frame and doors.

Insert surrounds come in three styles. For Franklin traditional models, choose an old-world style three-piece cast iron surround with rich details at the corners, keystone, and columns, or one of our steel surrounds with either 6-inch top and side panels or 6-inch top and 3-inch side panels. For installations where your Franklin insert does not rest on the hearth, we offer a 1 5/16-inch bottom cover to complete the surround.

Decorative Fronts are available in six different styles and a variety of finishes. Each front attaches in minutes to the 1-piece metal backer (available in Matte Black) and includes fireplace screens. Screens protect you and your family from inadvertently touching the hot glass – but without detracting from the overall view of the fireplace.

Decorative doors add visual interest and old-world charm to any fireplace.

The frames and door sets install in minutes to transform the look of the insert.

Doors are available in Matte Black, Hammered Pewter, and Stainless Steel.

To cover larger hearth openings, install the optional shroud. At 48 inches wide and just under 38 inches tall, it provides a clean transition between the surround and



*Franklin 25,000 Btu Fireplace Insert with 6 x 3 Metal Surround and Universal Shroud.*

the existing fireplace. The 2-inch bottom cover completes the shroud.



*Loft Series insert with surround in Matte Black and Stainless Steel.*

For the Loft DV Insert, choose a matching contemporary surround in all black or in black and stainless steel. The bold stainless steel panels top and bottom accentuate the clean horizontal look of the Loft Insert.

Complete your Loft insert with decorative glass – available in Polished Black, Blue Clear, and Clear Frost. Additional glass shapes and colors are available through your local hearth dealer.

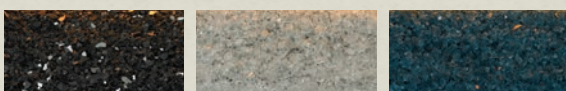

*Decorative Glass for the Loft Series fireplace can be placed on the floor of the firebox and is available in Polished Black, Clear Frost, and Blue Clear.*

# Options & Accessories

## Insert Surrounds



6 x 3 Metal Surround



6 x 6 Metal Surround



Cast Iron Surround



1-piece Metal Backer (used as surround)



6 x 3 Metal Surround with Universal Shroud

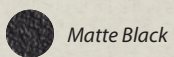

Matte Black



Hammered Pewter



Stainless Steel

# Options & Accessories

## Decorative Fronts

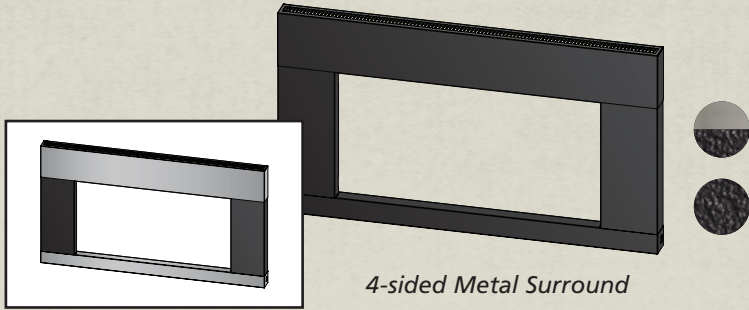

Stainless Steel & Flat Black Finish

4-sided Metal Surround

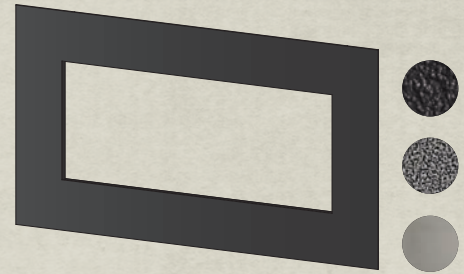

Float\*

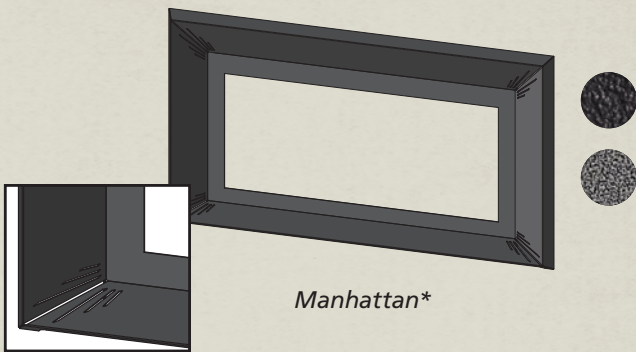

Manhattan\*

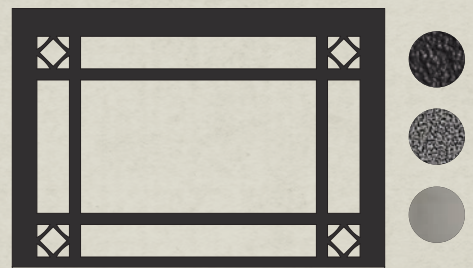

Jewel\*

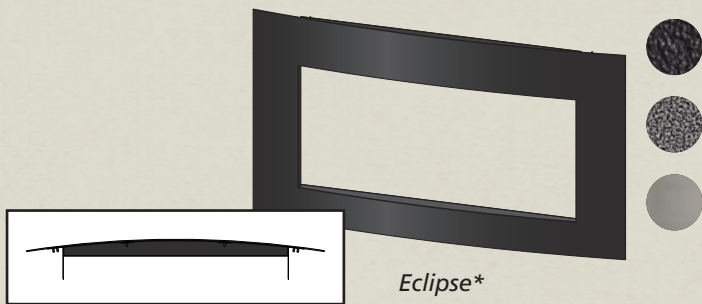

Eclipse (Top View)

Eclipse\*

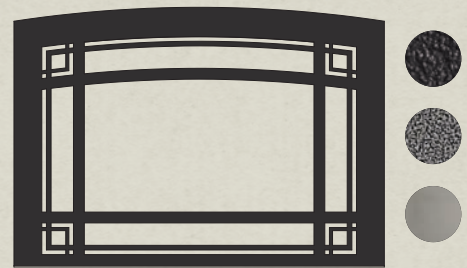

Lancaster\*



## Decorative Doors

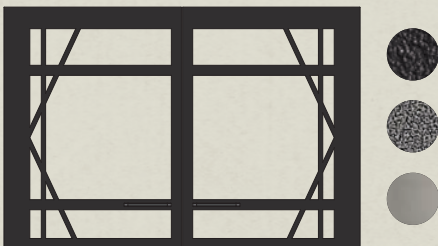

Tribeca\*



Transom\*



Horizon\*

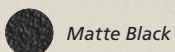

Matte Black

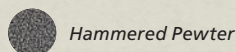

Hammered Pewter

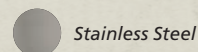

Stainless Steel

\*Requires 1-piece Metal Backer for Installation

# Options and Accessories

## *Control Options for Direct-Vent Inserts*

Lighting and managing a wood fire takes time and work – and more than a little patience to get it right. Your Franklin or Loft fireplace insert lights at the flick of a switch to produce consistent, reliable heat, even when electric power fails. Add the convenience of an optional thermostat, wireless wall thermostat, remote control, or thermostat remote control, and enjoy all the comfort of a warm cozy fire without the mess and hassle.



**FREC**  
Electric Remote Control  
Millivolt or IP

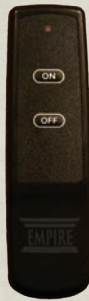

**FRBC**  
Remote  
Millivolt Only



**FRBTC**  
Thermostat Remote Control  
Millivolt or IP



**FRBTP**  
Programmable Remote Control  
Millivolt or IP



**FWS**  
Wall Switch  
Millivolt or IP



**TRW** Wireless  
Wall Thermostat  
Millivolt or IP



**TMV**  
Wall Thermostat  
Millivolt or IP

## *Decorative Louvers for Traditional Direct-Vent Inserts*

With four styles and three finishes from which to choose, our decorative louvers help create the perfect look for your Franklin traditional fireplace insert. Finishes include our rich matte black, contemporary hammered pewter, and modern stainless steel.

In addition to the traditional slat louvers, we offer a graceful Arched pattern, a geometric Mission pattern, and an elegant Leaf pattern.

All of our decorative louvers install in seconds without tools.



*Arch*



*Mission*



*Leaf*

## Traditional Direct-Vent Insert Dimensions

Model	A	B	C	D	E	F	G	H	I	J	K	L	M	N
DV25IN	19 3/4	28	14 1/2	11 1/8	25 1/4	12 3/4	17	18 5/16	27	6 3/4	9	20	25 5/8	40
DV33IN	22 3/4	31	16	14 1/8	28 1/4	14 1/4	18 3/4	21 5/16	30	8 1/4	10 1/2	21 1/2	28 5/8	43
DV35IN	24 3/4	34	16	16 1/8	31 1/4	14 1/4	21 3/4	23 5/16	33	8 1/4	10 1/2	23	30 5/8	46

\* Note: Illustrations shown are based on Direct-Vent models with 6 x 6-inch metal surround.

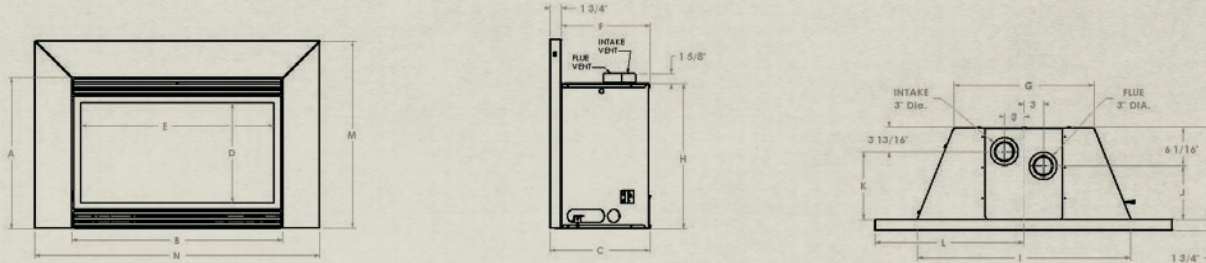

## Loft Direct-Vent Insert Dimensions

Model	A	B	C	D	E	F	G	H	I	J	K	L	M	N
DVL25IN	16 1/4	28	15 1/4	10 7/16	25 1/4	12 3/4	17	18 5/16	27	6 11/16	8 13/16	20	22 1/2	40
DVL33IN	19 1/4	31	16 3/4	13 7/16	28 1/4	14 1/4	18 3/4	21 5/16	30	8 3/16	10 7/16	21 1/2	25 1/2	43

\* Note: Illustrations shown are based on Direct-Vent models with 6 x 6 x 2-inch metal surround.

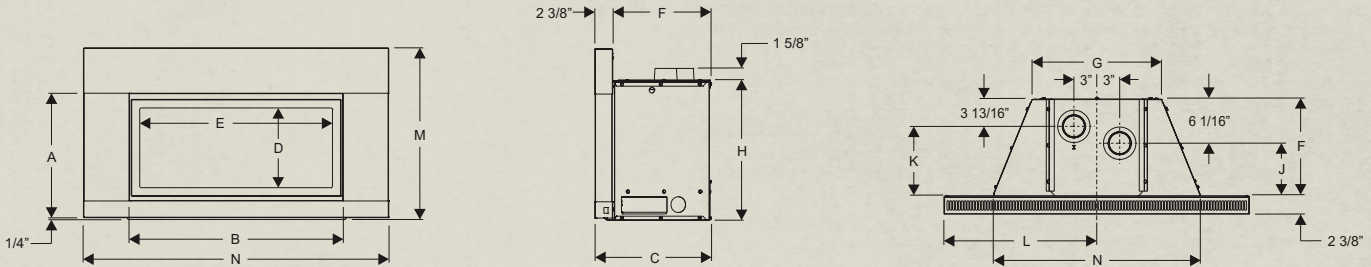

## Minimum Fireplace Opening Dimensions

Model	A	B	C	D
DV25IN	18 3/8	27 1/2	12 3/4	17 1/4
DV33IN	21 3/8	30 1/2	14 1/4	19
DV35IN	23 3/8	33 1/2	14 1/4	22
DVL25IN	18 3/8	27 1/2	12 3/4	17 1/4
DVL33IN	21 3/8	30 1/2	14 1/4	19

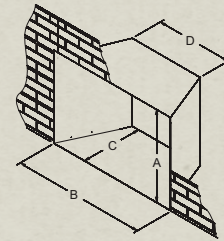

Gas Inlet		Warranty
Type of Gas (State on Order)	Natural or LP	All vented parts carry a 3-year limited warranty. Remote Controls carry a 1-year limited parts warranty.
Iron Pipe Size (N.P.T.)	1/2 inch	
Ignition Systems	Standing Pilot/Piezo or IP	

Empire Comfort Systems Inc., has manufactured safe, reliable heating systems for over 80 years. We take pride in our reputation for quality products, backed by the best sales, service, and distribution network in this industry. These fireplaces combine proven technologies with exceptional artistry and craftsmanship to add beauty and warmth to any home.

Member of the following industry associations:



Empire is committed to continuous product improvement; specifications are subject to change without notice. Dimensions in this brochure are approximate; read and follow the framing dimensions in the owners manual supplied with your Empire product. Flame size, shape, and color will vary from photos. Log Sets shown with Platinum Glowing Embers (PE20) and Ember Bed Kit (EK-1).

918 Freeburg Ave.  
Belleville, IL 62220-2623  
e-mail: info@empirecomfort.com

AH-00832 1/01/13